

CONTENTS

Digital Night Vision Rifle Scope

User Manual

Model: PQ1-4550

【Contents】

Product Description3
 User Guide5
 Key Parts6
 Operating Instructions7
 Battery Installation7
 Power On/ OFF8
 Observing9
 Adjusting Brightness of the Screen10
 Video Recording11
 Video Play Back12
 Files Deleting13

CONTENTS

Digital Zoom 14
 Mil Adjustment 15
 Display color set 18
 Time/Date Set 19
 External Monitor 20
 Connection to Computer 20
 Power Management 21
 Primary Parameters 22
 Standard Configuration 23
 Maintenance and safety instruction 24

PRODUCT DESCRIPTION

【Product Name】 Low-light Digital Night Vision Rifle Scope

【Model】 PQ1-4550

【Features】

- The PQ1-4550 digital night vision is used both in the day and at night. It is a multifunctional rifle scope used for aiming, video recording, playback and etc. The optical magnification is 4.5X and the digital magnification is 3X.
- Daytime Observation: observation & video/sound recording.
- Night Observation: In low-light environment the visual distance reaches up to 250 to 300 meters; while in pitch dark environment, [the external infrared illuminator is used to enhance its performance](#). The color of the display is optional, color, black & white (recommended), night green (recommended). It functions observing, video/sound recording and playback.

PRODUCT DESCRIPTION

- Built-in TF slot supports 4-32GB (8GB included). The memory card allow user to record 1-16 hours subject to its capacity.USB interface is available to connect it to a computer.
- A/V interface.
- Power Supply: Rechargeable lithium-Ion battery type 18650 (included)
- Battery duration: 2.5-3.5 hours.
- This product is an ideal tool to extend human vision.

USER GUIDE

【USER GUIDE】

● PQ1-4550 digital night vision riflescope is a precision optical electronics equipment which is used to observe or aim at a target. It can be used in extremely low light environment.

● Where it is completely dark an external infrared illuminator mounted to the riflescope assists you to view an object 400 meters away.

● In a pitch dark environment, please turn on the external IR illuminator (optional) and adjust its power level subject to the distance to the viewed object. It is equipped with an ultra-low light CMOS therefore the external IR illuminator is not necessary when starlight or street light is available.

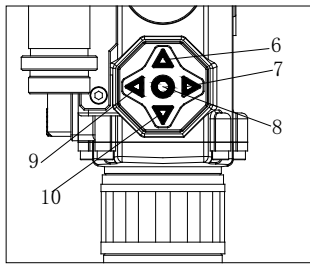

KEY PARTS

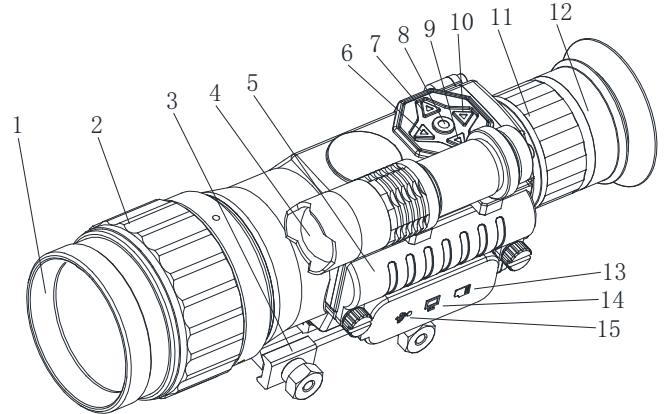

- | | |
|---------------------------|------------------------------|
| 1 – Objective Lens | 2 – Objective Focus Wheel |
| 3 – Picatinny adaptor | 4 – Auxiliary IR illuminator |
| 5 – Battery Cover | 6 – Adjustment Button |
| 7 – Adjustment Button | 8 – On/Off & Confirm |
| 9 – Adjustment Button | 10 – Adjustment Button |
| 11 – Eyepiece Focus Wheel | 12 – Eyepieces |
| 13 – TF Card Slot | 14 – Audio/Video Output |
| | 15 – TF Card Slot |

OPERATING INSTRUCTIONS

【Battery Installation】

- Unscrew the battery compartment cover off. Insert a piece of battery in the compartment with the negative end to the spring. Then screw the compartment cover tightly. Turn on the riflescope by pressing button #8
- If the built-in screen is not lit up, please make sure that the battery compartment is closed properly and tightly, and the battery is in correct direction with minimum voltage required.

【Precautions】

- Batteries should comply with relevant requirements;
- The battery should have sufficient power;
- Pay Notes to positive and negative poles and lay the battery correctly;
- Please return the riflescope to your vendor if it failed to work while the battery is in good condition.

OPERATING INSTRUCTIONS

【Power On】

- Take off the objective lens cap.
- Press Button #8 ○ and look through eyepieces #12. If the picture as shown here appears, the device is working properly.

Icon legend:

- 1 Video recording mode
- 2 System date/time
- 3 Reticle
- 4 Video duration available
- 5 TF card status
- 6 Battery level

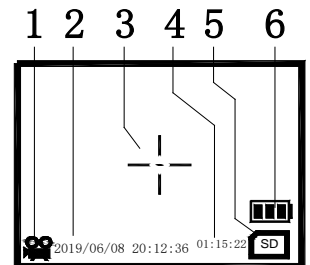

- As long as the device is turned on, it is ready for observing and video recording.

【Power Off】

- The riflescope will go off when you press button #8 ○ for 3 seconds regardless what mode it is in.
- In observation mode, it will go off automatically if no operation was performed for 20 minutes.

OPERATING INSTRUCTIONS

【Observing】





- Take off the objective lens cap and turn on the riflescope, aim at the target and look through the eyepieces (#12).
- 1. Adjust the diopter ring (#11) until the icon is clear.
- 2. Adjust the focus wheel (#2) until the scene is clear.
- Auxiliary infrared illumination is not needed under low light conditions.
- When the ambient light is too low to achieve a clear view of the object, please turn on the external auxiliary infrared illuminator to obtain a clear view of the object.

【Notes】

Always make sure that the ray path of the auxiliary IR illuminator is not blocked by anything.

OPERATING INSTRUCTIONS

【Adjusting Brightness of the Screen】

- The brightness of the display is determined by the average brightness level of the central area of the observed scene and is adjusted automatically.
- Meanwhile you can change it manually this way: Press button #6  for seconds to enter the SET mode, then press #6  to move “*” to the front of “Bri”.
- Press +(#7)  /-(#9)  to adjust the screen brightness between 1 and 20, 20 being the brightest.

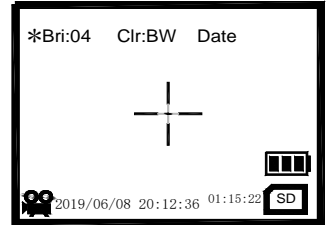

【Notes】

Current settings will be saved automatically if no operation was performed for 5 seconds, then it will return to the observation mode or video recording mode.

OPERATING INSTRUCTIONS

【Video Recording】

- In observation mode, press (#8)  once to start video recording. A video will be saved as individual files of 3-minute length and will be overwritten sequentially when the storage card is full. The resolution of video is 640x480 pixels.

Icon legend:



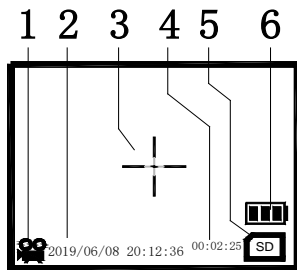



- 1 Video recording mode
- 2 System date/time
- 3 Reticle
- 4 Duration of the video being recorded
- 5 TF card status
- 6 Battery level



- When recording is started, time counter (4#) goes red and starts to count the time collapsed.
- Video is saved to the TF card simultaneously while recording.
- Press (#8)  to start or pause recording.

OPERATING INSTRUCTIONS

【Video Playback】

- In observation mode, press (#6)  to enter or quit video playback mode.
- Press (#8)  to start play, press it once again to stop the play.
- While playing, pres (#7)  to set the playback speed to 2x, 4x, or 8x forward, or (#9)  to set it to 2x, 4x, or 8x backward. Press #8  to pause while speeding up.
- Browse video files by pressing (#7)  and (#9) .
- The reticle is not recorded to comply with legal restrictions of some countries and regions.



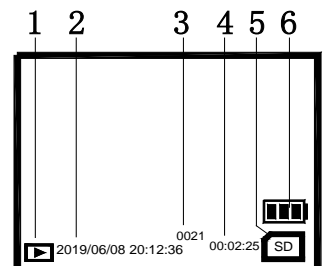

Icon legend:

- 1 Video playback mode
- 2 System date/time
- 3 File being played
- 4 Duration of the video selected
- 5 TF card status
- 6 Battery level



OPERATING INSTRUCTIONS

【Files Deleting】



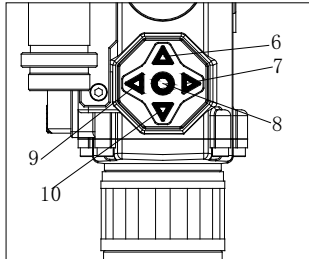
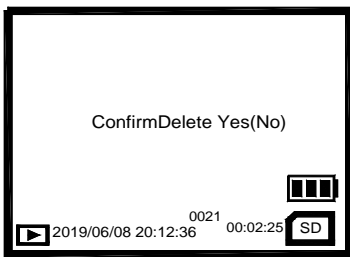

Press (#6)  for seconds in playback mode, a deletion confirmation will prompt as shown in the picture. Press (#9)  and (#7)  to switch between Yes and No, press (#8)  to confirm the operation. Press (#6)  again to quit.



13

OPERATING INSTRUCTIONS

【Digital Magnification】

- Digital zooming in a way of 3-step loop may be performed in observation mode, by pressing either button (#9)  or (#7) .
- By pressing button (#9)  or (#7)  at intervals the scene will be magnified in sequence of 1x-->2x-->3x-->1x respectively.

【Notes】

The maximum magnification is set to 3x to secure that the reticle is focused at the target without shifting away which may occur in case of more powerful magnification.

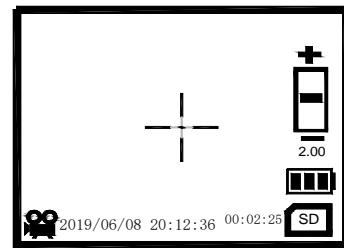





14

OPERATING INSTRUCTIONS

【Mil Adjustment】

Mil is adjusted by means of electronic way.

Press (#6)  to move the reticle upward and (#10)  downward; press (#7)  to move it rightward and (#9)  leftward.



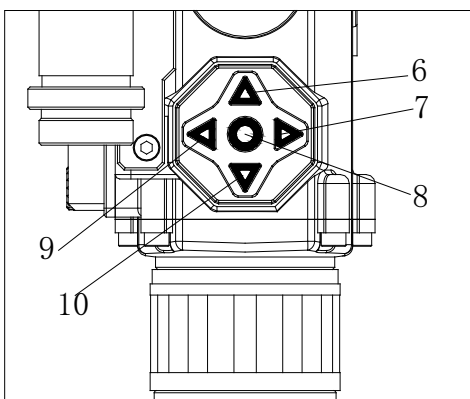



Displacement of each press is 1/8 mil.



15

OPERATING INSTRUCTIONS

【Mil Adjustment】

- In observation mode, press (#10)  for 3 seconds to enter the adjustment mode with figure of X axis and Y axis shown on the screen. Displacement of each step of both X and Y is 1/8 mil.
- Press (#7)  and (#9)  to make horizontal adjustment ---press (#9) to decrease the X value and move the reticle leftward, press (#7) to increase the X value and move the reticle rightward, X value ranging from -100 to 100.
- Press (#6)  and (#10)  to make vertical adjustment --- press (#10) to decrease the Y value and move the reticle downward, press (#6) to increase the Y value and move the reticle upward, Y value ranging from -100 to 100.
- Up completion, a confirmation "UDZ: No" prompts whether current position be set as User Defined Zero (UDZ). If no, just ignore the prompt and the system will save current settings 3 seconds later and exit adjustment mode; if yes, press (#9)  to switch it to "UDZ: Yes" and it will be saved automatically.

16

OPERATING INSTRUCTIONS

【Mil Adjustment】

- If UDZ needs to be restored to factory setting, enter Mil setting mode and press (#7)  for seconds until “Reset” appears, which implies that the system has been restored to factory setting.





【Notes】

Please perform Mil adjustment at 1X digital magnification so as to secure aiming accuracy. Mil adjustment performed at magnification of 2X or 3X should be intended for aiming at the same magnification only so that aiming accuracy is secured. It is recommended that Mil adjustment is done at 1X magnification.

It is recommended that X and Y value are set within -55 to +55, otherwise under circumstance of 2X or 3X magnification the reticle may escape from the screen.

OPERATING INSTRUCTIONS





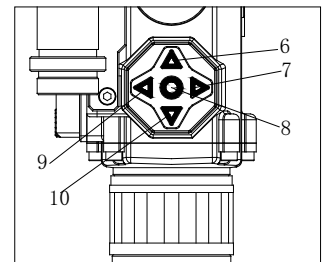
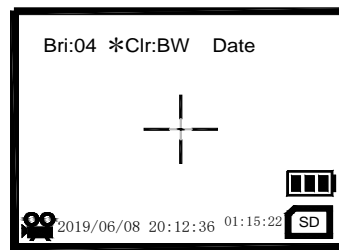



【Display Color Set】

- This riflescope has three display modes - Color, Black & White, and Green.
- Press (#6)  for seconds to enter the system setting mode. Press (#6)  to move “*” in front of Clr. BW as shown below.
- Press (#7)  and (#9)  to shift “*” to the front of “Clr: C”, “Clr: BW” and “Clr: GN” respectively.
- Clr: C stands for Color
- Clr: BW stands for Black & White
- Clr: GN stands for Green



OPERATING INSTRUCTIONS

【Date/Time Set】

- Press (#6)  for seconds to enter the system setting mode. Press (#6)  to move “*” to the front of Date as shown in the picture.
- Press (#7)  or (#9)  to enter the Date/Time setting mode.
- Press (#7)  or (#9)  to alter the figure between the two arrows
- Press (#8)  to shift the arrow pair to position of Year, Month, Date, Hour, Minute; item between the two arrows becomes adjustable.
- The date format is “YYYY/MM/DD HH: MM”
- Press (#8)  to quit the setting mode when arrows are at the position of minute.

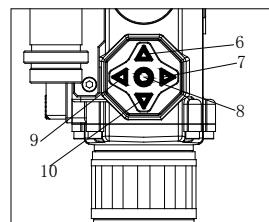
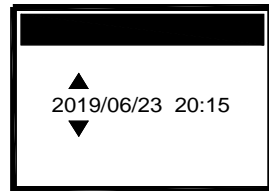
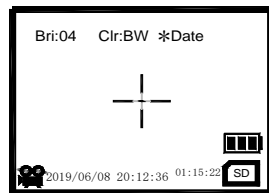

OPERATING INSTRUCTIONS

【External Monitor】

- Connect the riflescope to an external monitor via the AV interface #15.
- The built-in screen and external monitor may work simultaneously.

【Computer Connection】

- The riflescope is equipped with USB2.0 interface. You may connect it to a computer with an USB cable.
- When connected to a computer, the riflescope is identified as a storage device and files stored in the TF card may be accessed.
- When connected to a computer, battery in the riflescope will be charged.

【Notes】

When connected a computer, battery should be installed or external power source should be connected, otherwise data transfer may malfunction.

POWER MANAGEMENT**【Battery】**

- Please use lithium-ion rechargeable battery type 18650, 3.7V, 2200mAh.
- Battery should be charged for 10 hours prior to the first use to achieve its best performance.

【External Power Source】

- External power adaptor is included, which may supply power to the riflescope via an USB cable.
- When external power source is connected, the riflescope shall not power off automatically until you turn it off.
- When external power source is connected, the battery inside the device will be charged.

【Notes】

It is recommended that the battery is always charged with the battery charger to shorten charge time significantly.

PRIMARY PARAMETERS**【Technical Specifications】**

OPTICS	Magnification	4.5
	Dia. of objective lens	φ50mm
	Field of View	4.6° x 3.7°
	Range of eye relief	±5 diopter
	Visual distance in low light environment	5m~∞
	Visual distance	250-300m
	Anti-impact force	600G
POWER SUPPLY	Operating voltage	3.7V DC
	Battery	Rechargeable lithium battery
	Charging adaptor	5V/2A Adaptor
OTHER	Dimension (LxWxH)	220x80x75mm
	Weight	1102g

STANDARD CONFIGURATION**【Accessories】**

ITEM	QTY
AV cable	1
USB cable	1
External power adaptor	1
Battery charger	1
Manual	1
Hand strap	1
Battery 18650	1
Cleaning cloth	1
Infrared illuminator	1
TF card 8GB	1
Battery 14500 for illuminator	1

MAINTENANCE & INSTRUCTION**【Maintenance/Safety Instruction】**

- Store the riflescope in the soft bag.
- Ambient conditions for working: temperature -5°C and 40°C and humidity not exceeding 80%.
- Store the riflescope in a cool, dry and clean place. Prevent it against dampness, mildew, pressing, mechanical impact and long time exposure to sun light.
- If image flicking occurs, or the device cannot be powered on, it implies that the battery voltage is too low and should be charged.
- Blow away any dust or debris on the lens (or use a soft lens brush) before cleaning with the cleaning cloth.
- The battery should be charged occasionally even though the riflescope is not in use for a long period.

--	--